

Windows & Doors



About **ALCO** windows



Built. Installed. Guaranteed.

Fast, efficient, and honest, Alco Windows has become a reputable and well-known Window Producer and Installer. Our team is up for every job, managing projects with the skill and experience our clients have come to expect. We want our customers to be satisfied with our work, which is why we provide open communication channels throughout the duration of each project.

OUR MISSION

Since our founding, we've worked with numerous clients throughout the area. Great service begins and ends with experienced and friendly professionals, which is why we put so much consideration into selecting only the best to join our team. We complete projects efficiently and on schedule, and go above and beyond to form lasting relationships with our clients.

OUR VISION

We have the experience and skills necessary to tackle just about every type of job that comes our way. With Alco Windows, clients know exactly what to expect - professionalism, efficiency and exceptional results.

OUR VALUES

Alco Windows is committed to getting the job done, especially when it comes to this service. You can count on us to be professional, timely, efficient and make sure you're satisfied every step of the way.



Picture window

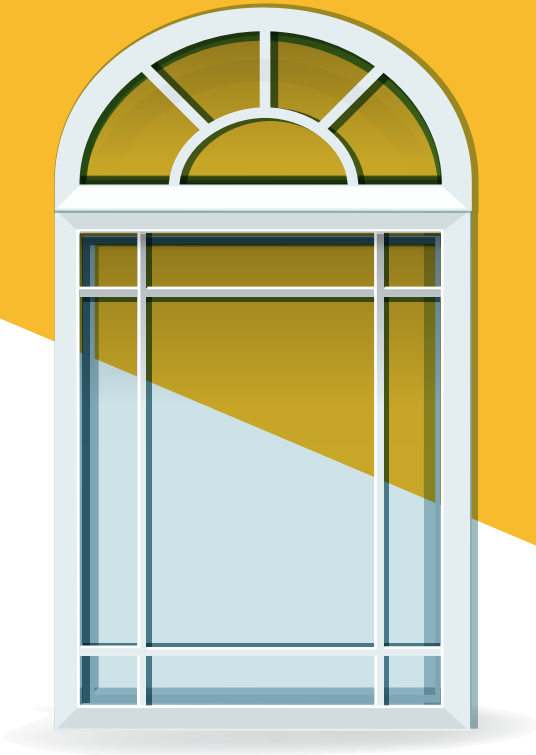

The most efficient and easy to go windows on market. Picture (unoperable) window or fixed lite is designed to withstand harsh weather conditions and comes in different colors and shapes. This can also be mullied to other types of windows as a side-lite or transom to create unique look and add the lite to your project

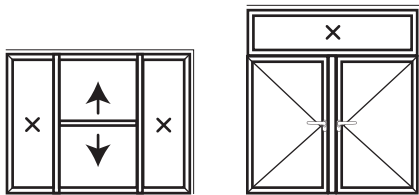

GRID OPTIONS

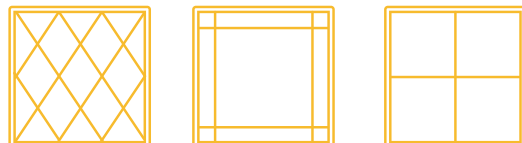

Double slider

- All welded head, sill and sash construction
- Beveled exterior face for efficient water runoff and aesthetic appeal
- Integral screen track
- Concealed tilt latch adds a clean, visual sightline at the locking rail and provides maximum security
- Dedicated sash profiles for improved air and water performance
- Dual weatherseal at the head and sill for all weather protection
- Integral vinyl lift rail for smooth fingertip operation
- PPG intercept/super spacer
- Integral vinyl interlock for maximum security and a weather-tight seal
- Double-tandem brass rollers for smooth operation



GRID OPTIONS



| | |
|--|-----------------------------|
| ENERGY STAR [®] QUALIFIED IN HIGHLIGHTED ZONES | |
| | |
| QUALIFIED IN ALL ZONES | |
| ALCO WINDOWS PLATINUM 7000 SERIES HORIZONTAL SLIDER Vinyl frame, Double glazed, Low E coating (40/0.027, 50), Argon-filled <small>(U, SHGC, UAW, AWE)</small> | |
| ENERGY PERFORMANCE RATINGS | |
| U-FACTOR (HLS-APP) | SOLAR HEAT GAIN COEFFICIENT |
| 0.28 | 0.30 |
| ADDITIONAL PERFORMANCE RATINGS | |
| VISIBLE TRANSMITTANCE | — |
| 0.55 | |
| <small>The manufacturer declares that these ratings conform to applicable NFRC procedures for determining window product performance. NFRC ratings are determined by a third party of independent certification and a qualified product code. NFRC does not warrant any product or claims nor warrant the availability of any window for any specific use. Consult manufacturer's literature for other product performance information. www.nfrc.org</small> | |

Air Infiltration: 15 CFM/Sq.Ft.
 Water penetration: 6.00 PSF
 Structural performance: 60.0 PSF
 Rating: H-R40

Double hung

- 1 All welded head, sill and sash construction
- 2 Beveled exterior face for efficient water run-off and aesthetic appeal
- 3 Integral screen track
- 4 Concealed tilt latch adds a clean, visual sightline at the locking rail and provides maximum security
- 5 Constant force balance system for smooth operation of sashes
- 6 Triple weatherseal at the head and sill for all weather protection
- 7 Integral vinyl lift rail for smooth fingertip operation
- 8 7/8" insulated glass units. High performance Low-E, argon gas filled glass is standard
- 9 PPG intercept / Superspacer
- 10 Integral vinyl interlock for maximum security and a weather-tight seal



GRID OPTIONS

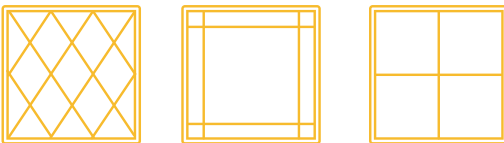

| | |
|--|---|
| ENERGY STAR [®] QUALIFIED IN HIGH-LIGHTED REGIONS | |
| | |
| QUALIFIED IN ALL ZONES | |
| | ALCO WINDOWS PLATINUM 7000 SERIES DOUBLE HUNG Vinyl Frame, Double Glazed, Low E Coating (Low-E2, 50), Argon Gas Filled (U-GAS-6000-2000) |
| ENERGY PERFORMANCE RATINGS | |
| U-FACTOR (U.S. A-91) | SOLAR HEAT GAIN COEFFICIENT |
| 0.28 | 0.30 |
| ADDITIONAL PERFORMANCE RATINGS | |
| VISIBLE TRANSMITTANCE | |
| 0.55 | — |
| <small>Manufacturer (Alco) has had these ratings verified in accordance with the AIAA-9000 procedures for determining window product performance. AIAA-9000 ratings are determined for a broad set of environmental conditions and a specific product size. AIAA-9000 does not guarantee any product and does not warrant the quality of any product for any specific use. Contact manufacturer's website for other product performance information.</small> | |

Casement / Awning

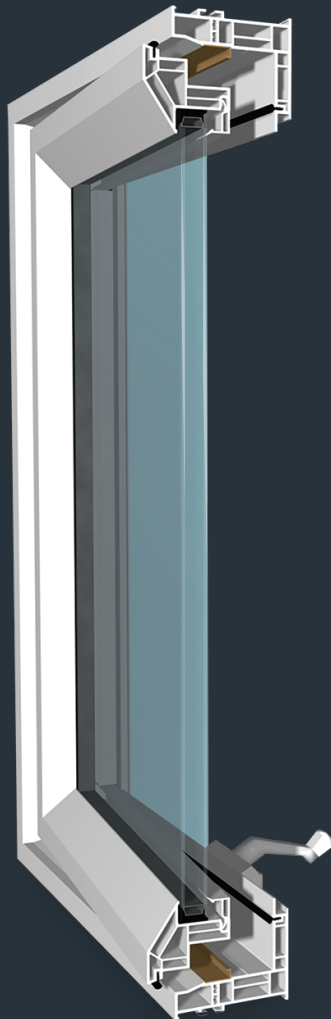

FEATURE AND BENEFITS

- Grade 50 performance
- Multi-point lock system with easy crank operating handle
- Dual weatherstripping
- Head drip fin for field milling
- One profile sash
- Common profiles produce casement, awning and Picture windows
- 3-1/4" frame for replacement window application
- Superspacer intercept PPG
- Beveled exterior sash design
- Truth "encore" casement hardware offering 90 degree opening for easy sash cleaning

THERMAL INSULATION

Climaguard rle 71/38

| Class | UC VALUE | R VALUE |
|-------------|----------|---------|
| clear | .49 | 2.05 |
| low-e | .29 | 2.38 |
| low-e/argon | .26 | 2.50 |

STRUCTURAL PERFORMANCE

| | |
|-------------------------|--------------|
| Air infiltration@ 25mph | .08 cfm/ft |
| Water penetration | 7.50 psf |
| Uniform loads | +/- 75.0 psf |

AAMA RATING: C-C50

GRID OPTIONS

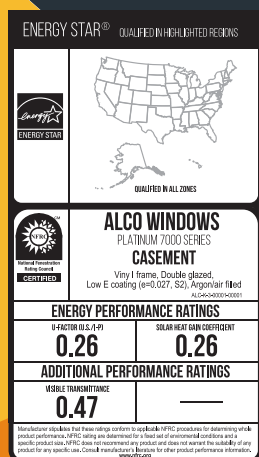
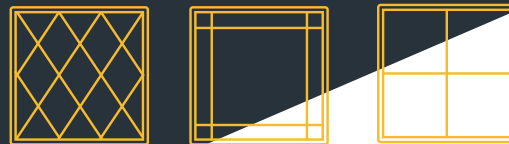

Bay/Bow



Our bay and bow windows are custom sized to your specification and can adapt to almost any type of replacement window. Our windows are available in bay, box-bay, and 3,4,5, or 6 lite bow configurations. Each unit can be made with a desired projection, therefore making each one is completely unique.

Designed to be both beautiful and functional, our bay and bow windows are the perfect addition to any home.

1" Hardwood cabinet-grade veneer head and seat board available in select white birch, red oak, and maple (maple used in lieu of birch on widths over 121 1/2" due to availability).

3/4" #1 Ponderosa pine struts allow for unlimited angles form 0 to 55 degrees.

3/4" Ponderosa pine and jambs (has secondary cover to hide unsightly installation nails and screws).

Two interior finishes - all wood or vinyl mullions, end fillers, and stops.

Sill has a unique weep system.

Maintenance-free vinyl exterior - available in white or beige

1/4" all-threaded steel rods between struts tie head and sill boards together for added strength

Fiberglass insulation fill between struts

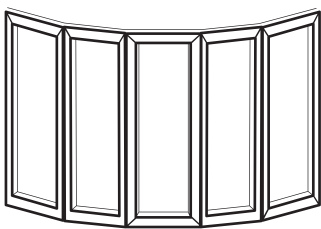

BOW WINDOW

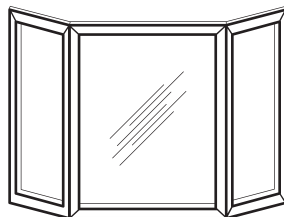

BAY WINDOW

Tilt & Turn window

Our most efficient operable window will add charm and strength to each and every project. Comes in different shapes and combinations. Numerous colors laminations (inside and out) and countless grids options will make any project to stand out.



POSITION 1



POSITION 2



POSITION 3

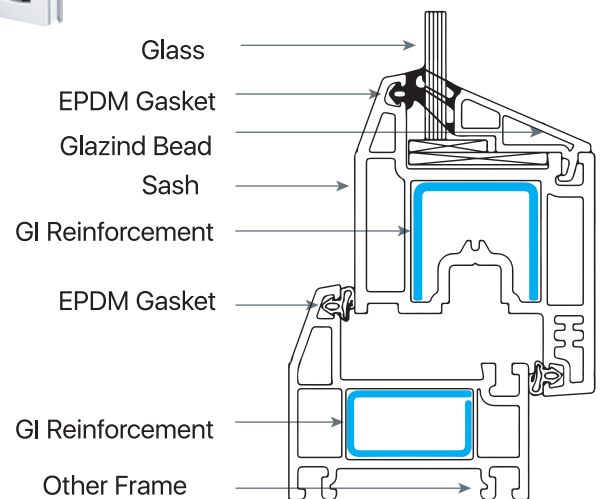
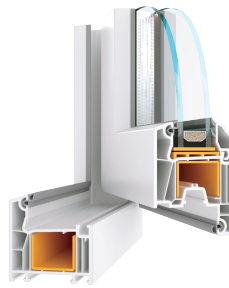
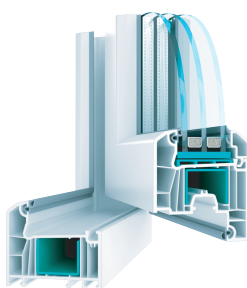

Types of windows and doors



Lamination



Color solutions

| | | | |
|--|-----------------|--|-------------|
| | Chocolate Brown | | Dark Gray |
| | Black Cherry | | Pearl White |
| | Dark Oak | | Golden Oak |
| | Dark Green | | Mahogany |
| | Sea Blue | | Purple |
| | Autumn Red | | Birch Tree |
| | Royal Blue | | Walnut |
| | Cloudy Gray | | Pine Tree |
| | Light Oak | | |
| | Forest Green | | |

Grid configurations

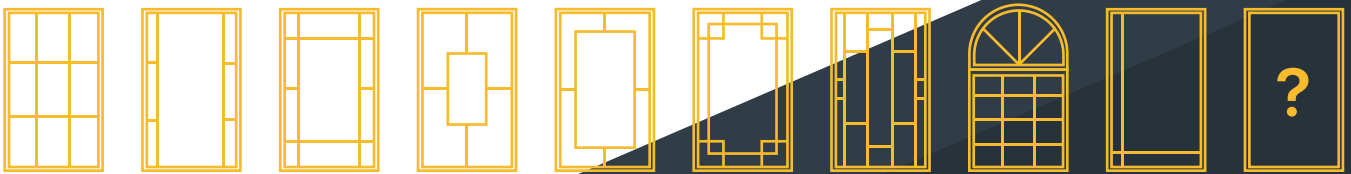

Shapes



Sliding patio door



- Unique welded vinyl monorail frame design for a weather-tight, secure installation
- Non-skid aluminum threshold & roller track covers for door panels & screens
- Heavy duty adjustable tandem ball bearing rollers
- Crescent inside door handle design with key lock
- Double weatherstripped with interlocking panel meeting rails
- 7/8" "warm-edge" tempered insulated glass
- Low-e glass/argon gas
- Secondary footlock standard for added security
- Heavy duty extruded screen with adjustable rollers top & bottom
- Limited lifetime warranty
- Two panel, three panel, & four panel door configurations
- Custom sizing

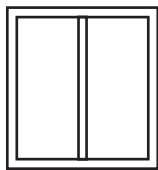

○ ×

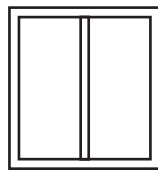

× ○



○ × ○

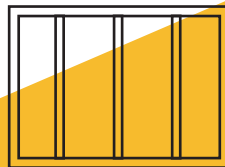

○ × × ○

Forms

Standard architectural shapes

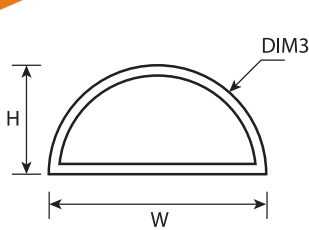

CIRCLE TOP

Required Dim: W, H
 Hight/ Radius=
 Exactly 1/2 the width

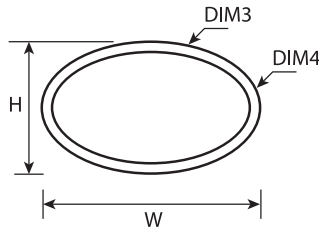

OVAL

Required Dim: W, H
 DIM4 (Minor Radius) must be
 above profile limits

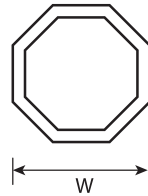

OCTAGONE

Required Dim: W
 On this style, all
 sides are equal

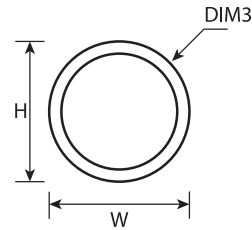

FULL CIRCLE

Required Dim: W
 Width and hight are equal
 Radius is exactly
 1/2 the width

Installations

For all types of installations visit: www.sevenstarsremodeling.com

Warranty

ALCO Windows & Services Lifetime Limited Warranty

This is to certify that the Windows and/or Doors installed on the premises of

Name of Owner _____

Address _____

Date _____

are fully warranted against defects in workmanship and materials under normal use and service for the LIFETIME of your ownership. The manufacturer agrees to repair and replace, AT THE FACTORY, FREE OF CHARGE, any returned product that is found to be defective due to a manufacturing defect. **Service calls for any reason after 1 year will be made at the prevailing rate.**

• Insulating glass warranty •

Alco windows warrants that its insulating glass units will be free from material obstruction of vision as a result of dust or film on the internal glass surface caused by failure of the hermetic seal due to faulty manufacturing of the unit for the LIFETIME of your ownership. Condensation on external glass surfaces does not indicate a faulty product. Stress cracks are warranted for six months.

This warranty does not apply to any of the following: damage incurred during or after installation, including but not limited to ripped, cut, torn or bent screen wire; or breakage, cracks or scratches in glass, faulty or improper installation, building construction, design or handling, or abuse, misuse, accidents, flood, fire or acts of God.

• Vinyl extrusion warranty •

The vinyl extrusion is warranted not to chip, peel, blister, rot or corrode. The vinyl is not warranted against fading or color change due to weather conditions, as weathering will cause any surface to gradually change.

THIS LIMITED WARRANTY IS IN LIEU OF ALL OTHER GUARANTEES AND WARRANTIES EXPRESS OR IMPLIED. ALCO WINDOWS MAKES NO OTHER EXPRESS OR IMPLIED REPRESENTATION OR WARRANTY OF ANY KIND, WHETHER AS TO MERCHANTABILITY, FITNESS FOR A PARTICULAR PURPOSE OR USE, OR ANY OTHER MATTER. ALCO WINDOWS SHALL NOT BE RESPONSIBLE FOR ANY CONSEQUENTIAL OR INCIDENTAL DAMAGES.

Paid invoice required with all claims.

Alco Windows & Services, Inc.





Built Installed Guaranteed

ALCO

WINDOWS & SERVICES

518 Browns Lane, Croydon PA 19021

Call: 215-464-3383

Text: 267-401-5274 Fax: 855-737-8277

Email alcowindowssales@gmail.com

www.alcowindows.com